



Cambridge International AS & A Level

CANDIDATE
NAME

CENTRE
NUMBER

--	--	--	--	--

CANDIDATE
NUMBER

--	--	--	--



PHYSICS

9702/51

Paper 5 Planning, Analysis and Evaluation

May/June 2020

1 hour 15 minutes

You must answer on the question paper.

No additional materials are needed.

INSTRUCTIONS

- Answer **all** questions.
- Use a black or dark blue pen. You may use an HB pencil for any diagrams or graphs.
- Write your name, centre number and candidate number in the boxes at the top of the page.
- Write your answer to each question in the space provided.
- Do **not** use an erasable pen or correction fluid.
- Do **not** write on any bar codes.
- You may use a calculator.
- You should show all your working and use appropriate units.

INFORMATION

- The total mark for this paper is 30.
- The number of marks for each question or part question is shown in brackets [].

This document has **8** pages. Blank pages are indicated.

2

- 1 A student investigates springs made of metal wire, as shown in Fig. 1.1.

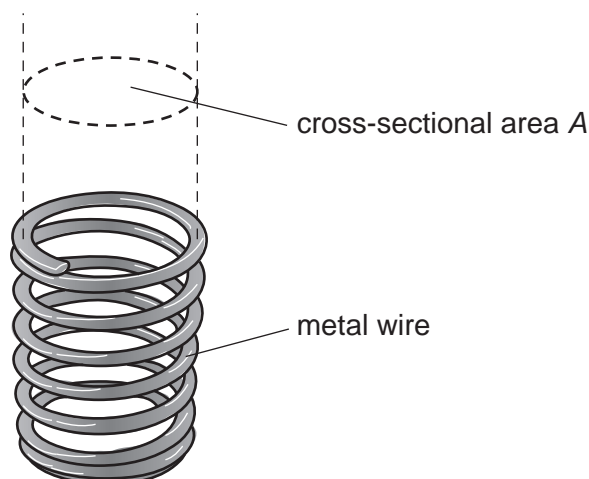

Fig. 1.1

The student constructs several springs from wire of thickness t . Each spring has a different cross-sectional area A .

The student investigates how the spring constant k varies with A .

It is suggested that the relationship between k and A is

$$k = \frac{\beta \rho t^4}{A^{\frac{3}{2}} N}$$

where ρ is the density of the metal, N is the number of turns of wire on the spring and β is a constant.

Design a laboratory experiment to test the relationship between k and A . Explain how your results could be used to determine a value for β .

You should draw a diagram, on page 3, showing the arrangement of your equipment. In your account you should pay particular attention to:

- the procedure to be followed
- the measurements to be taken
- the control of variables
- the analysis of the data
- any safety precautions to be taken.

Diagram

.....

.....

.....

.....

.....

.....

.....

.....

.....

.....

.....

.....

.....

.....

.....

.....

.....

.....

.....

.....

.....

.....

.....

- 2 A student investigates the discharge of a capacitor through a resistor using the circuit shown in Fig. 2.1.

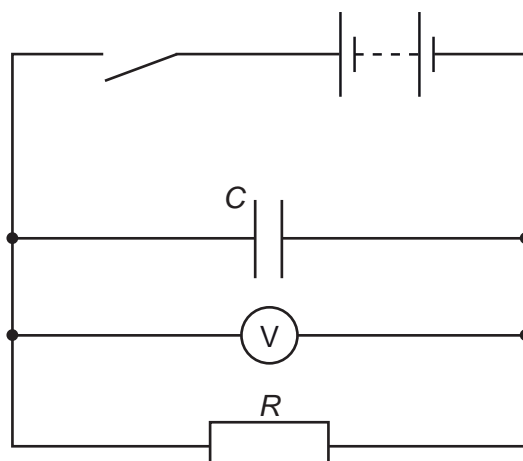

Fig. 2.1

The student initially closes the switch and charges the capacitor. The switch is then opened and a stop-watch is started. The capacitor discharges through the resistor. At time t the potential difference V across the capacitor is measured.

It is suggested that V and t are related by the equation

$$V = \left(\frac{Q_0}{C}\right)e^{-\left(\frac{t}{RC}\right)}$$

where Q_0 is the charge of the fully charged capacitor, C is the capacitance of the capacitor and R is the resistance of the resistor.

- (a) A graph is plotted of $\ln V$ on the y -axis against t on the x -axis.

Determine expressions for the gradient and y -intercept.

gradient =

y -intercept =

[1]

(b) Values of t and V are given in Table 2.1.

Table 2.1

t/s	V/V	$\ln(V/V)$
0	6.2 ± 0.2	
6	4.6 ± 0.2	
12	3.4 ± 0.2	
18	2.6 ± 0.2	
24	2.0 ± 0.2	
30	1.4 ± 0.2	

Calculate and record values of $\ln(V/V)$ in Table 2.1.

Include the absolute uncertainties in $\ln(V/V)$.

[2]

(c) (i) Plot a graph of $\ln(V/V)$ against t/s .
Include error bars for $\ln(V/V)$.

[2]

(ii) Draw the straight line of best fit and a worst acceptable straight line on your graph. Both lines should be clearly labelled.

[2]

(iii) Determine the gradient of the line of best fit. Include the absolute uncertainty in your answer.

gradient = [2]

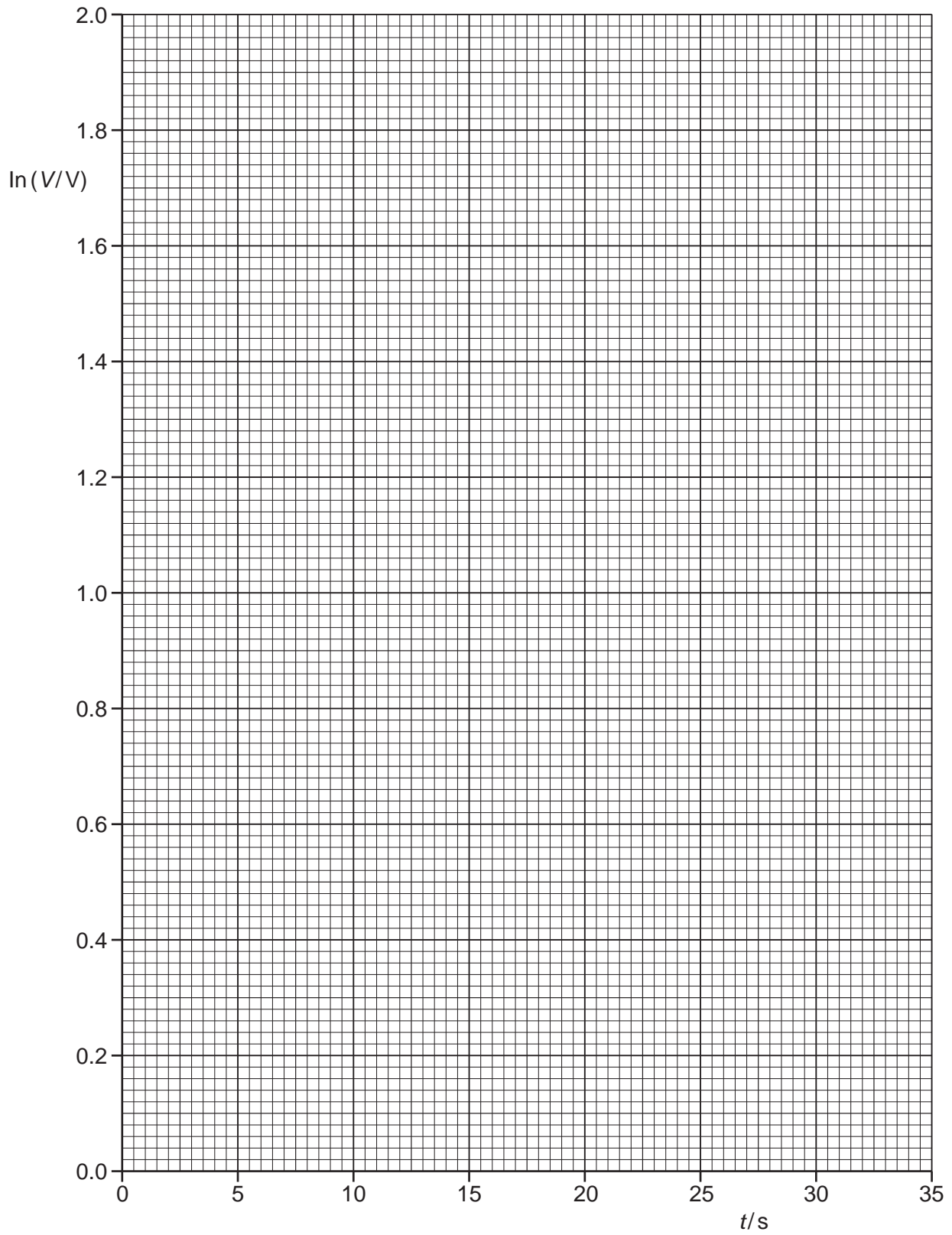

- (iv) Determine the y -intercept of the line of best fit. Do **not** include the absolute uncertainty in your answer.

y -intercept = [1]

- (d) (i) Using your answers to (a), (c)(iii) and (c)(iv), determine values of C and Q_0 . Include appropriate units.

Data: $R = 39 \text{ k}\Omega$

$C = \dots\dots\dots$

$Q_0 = \dots\dots\dots$ [3]

- (ii) The percentage uncertainty in the value of R is 5%.

Determine the absolute uncertainty in C .

absolute uncertainty in $C = \dots\dots\dots$ [1]

- (e) Using your results, determine the value of V when the time t is 1.0 minute.

$V = \dots\dots\dots V$ [1]

[Total: 15]